

The Flow of Dry Water

40-1 Hydrostatics

The subject of the flow of fluids, and particularly of water, fascinates everybody. We can all remember, as children, playing in the bathtub or in mud puddles with the strange stuff. As we get older, we watch streams, waterfalls, and whirlpools, and we are fascinated by this substance which seems almost alive relative to solids. The behavior of fluids is in many ways very unexpected and interesting—it is the subject of this chapter and the next. The efforts of a child trying to dam a small stream flowing in the street and his surprise at the strange way the water works its way out has its analog in our attempts over the years to understand the flow of fluids. We have tried to dam the water up—in our understanding—by getting the laws and the equations that describe the flow. We will describe these attempts in this chapter. In the next chapter, we will describe the unique way in which water has broken through the dam and escaped our attempts to understand it.

We suppose that the elementary properties of water are already known to you. The main property that distinguishes a fluid from a solid is that a fluid cannot *maintain* a shear stress for any length of time. If a shear is applied to a fluid, it will move under the shear. Thicker liquids like honey move less easily than fluids like air or water. The measure of the ease with which a fluid yields is its viscosity. In this chapter we will consider only situations in which the viscous effects can be ignored. The effects of viscosity will be taken up in the next chapter.

We begin by considering *hydrostatics*, the theory of liquids at rest. When liquids are at rest, there are no shear forces (even for viscous liquids). The law of hydrostatics, therefore, is that the stresses are always normal to any surface inside the fluid. The normal force per unit area is called the *pressure*. From the fact that there is no shear in a static fluid it follows that the pressure stress is the same in all directions (Fig. 40-1). We will let you entertain yourself by proving that if there is no shear on any plane in a fluid, the pressure must be the same in any direction.

The pressure in a fluid may vary from place to place. For example, in a static fluid at the earth's surface the pressure will vary with height because of the weight of the fluid. If the density ρ of the fluid is considered constant, and if the pressure at some arbitrary zero level is called p_0 (Fig. 40-2), then the pressure at a height h above this point is $p = p_0 - \rho gh$, where g is the gravitational force per unit mass. The combination

$$p + \rho gh$$

is, therefore, a constant in the static fluid. This relation is familiar to you, but we will now derive a more general result of which it is a special case.

If we take a small cube of water, what is the net force on it from the pressure? Since the pressure at any place is the same in all directions, there can be a net force per unit volume only because the pressure varies from one point to another. Suppose that the pressure is varying in the x -direction—and we take the coordinate directions parallel to the cube edges. The pressure on the face at x gives the force $p \Delta y \Delta z$ (Fig. 40-3), and the pressure on the face at $x + \Delta x$ gives the force $[p + (\partial p / \partial x) \Delta x] \Delta y \Delta z$, so that the resultant force is $-(\partial p / \partial x) \Delta x \Delta y \Delta z$. If we take the remaining pairs of faces of the cube, we easily see that the pressure force per unit volume is $-\nabla p$. If there are other forces in addition—such as gravity—then the pressure must balance them to give equilibrium.

40-1 Hydrostatics

40-2 The equations of motion

40-3 Steady flow—Bernoulli's theorem

40-4 Circulation

40-5 Vortex lines

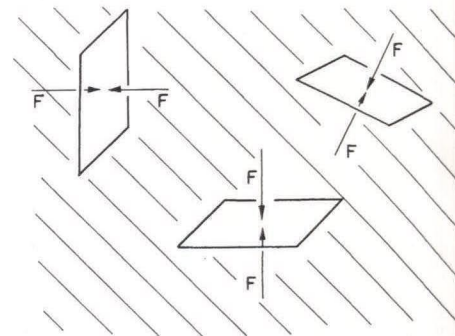

Fig. 40-1. In a static fluid the force per unit area across any surface is normal to the surface and is the same for all orientations of the surface.

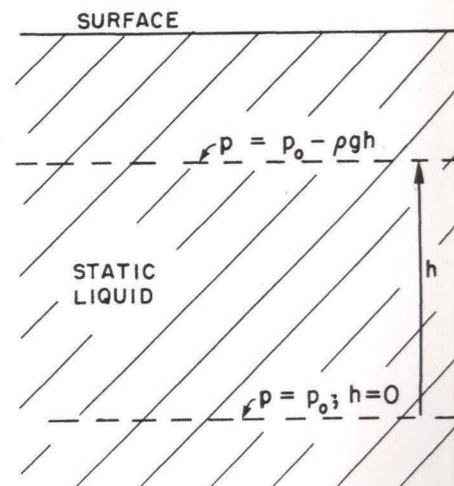

Fig. 40-2. The pressure in a static liquid.

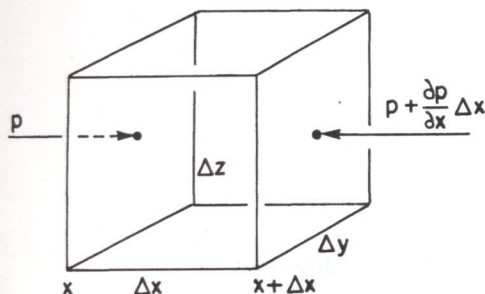

Fig. 40-3. The net pressure force on a cube is $-\nabla p$ per unit volume.

Let's take a circumstance in which such an additional force can be described by a potential energy, as would be true in the case of gravitation; we will let ϕ stand for the potential energy per unit mass. (For gravity, for instance, ϕ is just gz .) The force per unit mass is given in terms of the potential by $-\nabla\phi$, and if ρ is the density of the fluid, the force per unit volume is $-\rho\nabla\phi$. For equilibrium this force per unit volume added to the pressure force per unit volume must give zero:

$$-\nabla p - \rho\nabla\phi = 0. \quad (40.1)$$

Equation (40.1) is the equation of hydrostatics. In general, it has no solution. If the density varies in space in an arbitrary way, there is no way for the forces to be in balance, and the fluid cannot be in static equilibrium. Convection currents will start up. We can see this from the equation since the pressure term is a pure gradient, whereas for variable ρ the other term is not. Only when ρ is a constant is the potential term a pure gradient. Then the equation has a solution

$$p + \rho\phi = \text{const.}$$

Another possibility which allows hydrostatic equilibrium is for ρ to be a function only of p . However, we will leave the subject of hydrostatics because it is not nearly so interesting as the situation when fluids are in motion.

40-2 The equations of motion

First, we will discuss fluid motions in a purely abstract, theoretical way and then consider special examples. To describe the motion of a fluid, we must give its properties at every point. For example, at different places, the water (let us call the fluid "water") is moving with different *velocities*. To specify the character of the flow, therefore, we must give the three components of velocity at every point and for any time. If we can find the equations that determine the velocity, then we would know how the liquid moves at all times. The velocity, however, is not the only property that the fluid has which varies from point to point. We have just discussed the variation of the *pressure* from point to point. And there are still other variables. There may also be a variation of *density* from point to point. In addition, the fluid may be a conductor and carry an electric *current* whose density \mathbf{j} varies from point to point in magnitude and direction. There may be a *temperature* which varies from point to point, or a *magnetic field*, and so on. So the number of fields needed to describe the complete situation will depend on how complicated the problem is. There are interesting phenomena when currents and magnetism play a dominant part in determining the behavior of the fluid; the subject is called *magnetohydrodynamics*, and great attention is being paid to it at the present time. However, we are not going to consider these more complicated situations because there are already interesting phenomena at a lower level of complexity, and even the more elementary level will be complicated enough.

We will take the situation where there is no magnetic field and no conductivity, and we will not worry about the temperature because we will suppose that the density and pressure determine in a unique manner the temperature at any point. As a matter of fact, we will reduce the complexity of our work by making the assumption that the density is a constant—we imagine that the fluid is essentially incompressible. Putting it another way, we are supposing that the variations of pressure are so small that the changes in density produced thereby are negligible. If that is not the case, we would encounter phenomena additional to the ones we will be discussing here—for example, the propagation of sound or of shock waves. We have already discussed the propagation of sound and shocks to some extent, so we will now isolate our consideration of hydrodynamics from these other phenomena by making the approximation that the density ρ is a constant. It is easy to determine when the approximation of constant ρ is a good one. We can say that if the velocities of flow are much less than the speed of a sound wave in the fluid, we do not have to worry about variations in density. The escape that water makes in our attempts to understand it is not related to the approximation of

constant density. The complications that do permit the escape will be discussed in the next chapter.

In the general theory of fluids one must begin with an *equation of state* for the fluid which connects the pressure to the density. In our approximation this equation of state is simply

$$\rho = \text{const.}$$

This then is the first relation for our variables. The next relation expresses the conservation of matter—if matter flows away from a point, there must be a decrease in the amount left behind. If the fluid velocity is v , then the mass which flows in a unit time across a unit area of surface is the component of ρv normal to the surface. We have had a similar relation in electricity. We also know from electricity that the divergence of such a quantity gives the rate of decrease of the density per unit time. In the same way, the equation

$$\nabla \cdot (\rho v) = - \frac{\partial \rho}{\partial t} \quad (40.2)$$

expresses the conservation of mass for a fluid; it is the hydrodynamic *equation of continuity*. In our approximation, which is the incompressible fluid approximation, ρ is a constant, and the equation of continuity is simply

$$\nabla \cdot v = 0. \quad (40.3)$$

The fluid velocity v —like the magnetic field B —has zero divergence. (The hydrodynamic equations are often closely analogous to the electrodynamic equations; that's why we studied electrodynamics first. Some people argue the other way; they think that one should study hydrodynamics first so that it will be easier to understand electricity afterwards. But electrodynamics is really much easier than hydrodynamics.)

We will get our next equation from Newton's law which tells us how the velocity changes because of the forces. The mass of an element of volume of the fluid times its acceleration must be equal to the force on the element. Taking an element of unit volume, and writing the force per unit volume as f , we have

$$\rho \times (\text{acceleration}) = f.$$

We will write the force density as the sum of three terms. We have already considered the pressure force per unit volume, $-\nabla p$. Then there are the "external" forces which act at a distance—like gravity or electricity. When they are conservative forces with a potential per unit mass, ϕ , they give a force density $-\rho \nabla \phi$. (If the external forces are not conservative, we would have to write f_{ext} for the external force per unit volume.) Then there is another "internal" force per unit volume, which is due to the fact that in a *flowing* fluid there can also be a shearing stress. This is called the viscous force, which we will write f_{visc} . Our equation of motion is

$$\rho \times (\text{acceleration}) = -\nabla p - \rho \nabla \phi + f_{\text{visc}}. \quad (40.4)$$

For this chapter we are going to suppose that the liquid is "thin" in the sense that the viscosity is unimportant, so we will omit f_{visc} . When we drop the viscosity term, we will be making an approximation which describes some ideal stuff rather than real water. John von Neumann was well aware of the tremendous difference between what happens when you don't have the viscous terms and when you do, and he was also aware that, during most of the development of hydrodynamics until about 1900, almost the main interest was in solving beautiful *mathematical* problems with this approximation which had almost nothing to do with real fluids. He characterized the theorist who made such analyses as a man who studied "dry water." Such analyses leave out an *essential* property of the fluid. It is because we are leaving this property out of our calculations in this chapter that we have given it the title "The Flow of Dry Water." We are postponing a discussion of *real* water to the next chapter.

Fig. 40-4. The acceleration of a fluid particle.

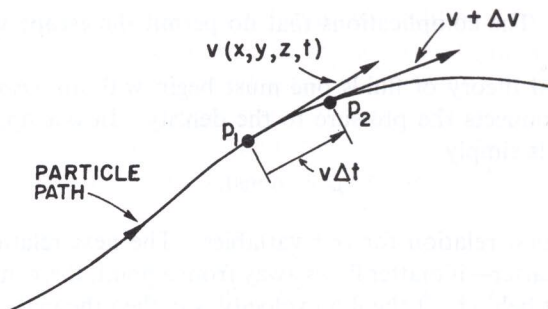

If we leave out f_{visc} , we have in Eq. (40.4) everything we need except an expression for the acceleration. You might think that the formula for the acceleration of a fluid particle would be very simple, for it seems obvious that if v is the velocity of a fluid particle at some place in the fluid, the acceleration would just be $\partial v / \partial t$. *It is not*—and for a rather subtle reason. The derivative $\partial v / \partial t$, is the rate at which the velocity $v(x, y, z, t)$ changes at a *fixed point* in space. What we need is how fast the velocity changes for a *particular piece* of fluid. Imagine that we mark one of the drops of water with a colored speck so we can watch it. In a small interval of time Δt , this drop will move to a different location. If the drop is moving along some path as sketched in Fig. 40-4, it might in Δt move from P_1 to P_2 . In fact, it will move in the x -direction by an amount $v_x \Delta t$, in the y -direction by the amount $v_y \Delta t$, and in the z -direction by the amount $v_z \Delta t$. We see that, if $v(x, y, z, t)$ is the velocity of the fluid particle which is at (x, y, z) at the time t , then the velocity of the *same* particle at the time $t + \Delta t$ is given by $v(x + \Delta x, y + \Delta y, z + \Delta z, t + \Delta t)$ —with

$$\Delta x = v_x \Delta t, \quad \Delta y = v_y \Delta t, \quad \text{and} \quad \Delta z = v_z \Delta t.$$

From the definition of the partial derivatives—recall Eq. (2.7)—we have, to first order, that

$$\begin{aligned} v(x + v_x \Delta t, y + v_y \Delta t, z + v_z \Delta t, t + \Delta t) \\ = v(x, y, z, t) + \frac{\partial v}{\partial x} v_x \Delta t + \frac{\partial v}{\partial y} v_y \Delta t + \frac{\partial v}{\partial z} v_z \Delta t + \frac{\partial v}{\partial t} \Delta t. \end{aligned}$$

The acceleration $\Delta v / \Delta t$ is

$$v_x \frac{\partial v}{\partial x} + v_y \frac{\partial v}{\partial y} + v_z \frac{\partial v}{\partial z} + \frac{\partial v}{\partial t}.$$

We can write this symbolically—treating ∇ as a vector—as

$$(v \cdot \nabla)v + \frac{\partial v}{\partial t}. \quad (40.5)$$

Note that there can be an acceleration even though $\partial v / \partial t = 0$ so that velocity at a *given point* is not changing. As an example, water flowing in a circle at a constant speed is accelerating even though the velocity at a given point is not changing. The reason is, of course, that the velocity of a particular piece of water which is initially at one point on the circle has a different direction a moment later; there is a centripetal acceleration.

The rest of our theory is just mathematical—finding solutions of the equation of motion we get by putting the acceleration (40.5) into Eq. (40.4). We get

$$\frac{\partial v}{\partial t} + (v \cdot \nabla)v = -\frac{\nabla p}{\rho} - \nabla \phi, \quad (40.6)$$

where viscosity has been omitted. We can rearrange this equation by using the following identity from vector analysis:

$$(v \cdot \nabla)v = (\nabla \times v) \times v + \frac{1}{2} \nabla(v \cdot v).$$

If we now define a new vector field Ω , as the curl of v ,

$$\Omega = \nabla \times v, \quad (40.7)$$

the vector identity can be written as

$$(v \cdot \nabla)v = \Omega \times v + \frac{1}{2} \nabla v^2,$$

and our equation of motion (40.6) becomes

$$\frac{\partial v}{\partial t} + \Omega \times v + \frac{1}{2} \nabla v^2 = -\frac{\nabla p}{\rho} - \nabla \phi. \quad (40.8)$$

You can verify that Eqs. (40.6) and (40.8) are equivalent by checking that the components of the two sides of the equation are equal—and making use of (40.7).

The vector field Ω is called the *vorticity*. If the vorticity is zero everywhere, we say that the flow is *irrotational*. We have already defined in Section 3-5 a thing called the *circulation* of a vector field. The circulation around any closed loop in a fluid is the line integral of the fluid velocity, at a given instant of time, around that loop:

$$(\text{Circulation}) = \oint v \cdot ds.$$

The circulation *per unit area* for an infinitesimal loop is then—using Stokes' theorem—equal to $\nabla \times v$. So the vorticity Ω is the circulation around a unit area (perpendicular to the direction of Ω). It also follows that if you put a little piece of dirt—not an infinitesimal point—at any place in the liquid it will rotate with the angular velocity $\Omega/2$. Try to see if you can prove that. You can also check it out that for a bucket of water on a turntable, Ω is equal to twice the local angular velocity of the water.

If we are interested only in the velocity field, we can eliminate the pressure from our equations. Taking the curl of both sides of Eq. (40.8), remembering that ρ is a constant and that the curl of any gradient is zero, and using Eq. (40.3), we get

$$\frac{\partial \Omega}{\partial t} + \nabla \times (\Omega \times v) = 0. \quad (40.9)$$

This equation, together with the equations

$$\Omega = \nabla \times v \quad (40.10)$$

and

$$\nabla \cdot v = 0, \quad (40.11)$$

describes completely the velocity field v . Mathematically speaking, if we know Ω at some time, then we know the curl of the velocity vector, and we also know that its divergence is zero, so given the physical situation we have all we need to determine v everywhere. (It is just like the situation in magnetism where we had $\nabla \cdot B = 0$ and $\nabla \times B = j/\epsilon_0 c^2$.) Thus, a given Ω determines v just as a given j determines B . Then, knowing v , Eq. (40.9) tells us the rate of change of Ω from which we can get the new Ω for the next instant. Using Eq. (40.10), again we find the new v , and so on. You see how these equations contain all the machinery for calculating the flow. Note, however, that this procedure gives the velocity field only; we have lost all information about the pressure.

We point out one special consequence of our equation. If $\Omega = 0$ everywhere at any time t , $\partial \Omega / \partial t$ also vanishes, so that Ω is still zero everywhere at $t + \Delta t$. We have a solution to the equation; the flow is permanently irrotational. If a flow was started with zero rotation, it would always have zero rotation. The equations to be solved then are

$$\nabla \cdot v = 0, \quad \nabla \times v = 0.$$

They are just like the equations for the electrostatic or magnetostatic fields in free space. We will come back to them and look at some special problems later.

40-3 Steady flow—Bernoulli's theorem

Now we want to return to the equation of motion, Eq. (40.8), but limit ourselves to situations in which the flow is "steady." By steady flow we mean that at any one place in the fluid the velocity never changes. The fluid at any point is always replaced by new fluid moving in exactly the same way. The velocity picture always looks the same— v is a static vector field. In the same way that we drew "field lines" in magnetostatics, we can now draw lines which are always tangent to the fluid velocity as shown in Fig. 40-5. These lines are called *streamlines*. For steady flow, they are evidently the actual paths of fluid particles. (In unsteady flow the streamline pattern changes in time, and the streamline pattern at any instant does not represent the path of a fluid particle.)

A steady flow does not mean that nothing is happening—atoms in the fluid are moving and changing their velocities. It only means that $\partial v/\partial t = 0$. Then if we take the dot product of v into the equation of motion, the term $v \cdot (\Omega \times v)$ drops out, and we are left with

$$v \cdot \nabla \left\{ \frac{p}{\rho} + \phi + \frac{1}{2} v^2 \right\} = 0. \quad (40.12)$$

This equation says that for a small displacement in the direction of the fluid velocity the quantity inside the brackets doesn't change. Now in steady flow all displacements are along streamlines, so Eq. (40.12) tells us that for all the points along a streamline, we can write

$$\frac{p}{\rho} + \frac{1}{2} v^2 + \phi = \text{const (streamline)}. \quad (40.13)$$

This is *Bernoulli's theorem*. The constant may in general be different for different streamlines; all we know is that the left-hand side of Eq. (40.13) is the same all along a given streamline. Incidentally, we may notice that for steady *irrotational* motion for which $\Omega = 0$, the equation of motion (40.8) gives us the relation

$$\nabla \left\{ \frac{p}{\rho} + \frac{1}{2} v^2 + \phi \right\} = 0,$$

so that

$$\frac{p}{\rho} + \frac{1}{2} v^2 + \phi = \text{const (everywhere)}. \quad (40.14)$$

It's just like Eq. (40.13) *except* that now the constant has the same value throughout the fluid.

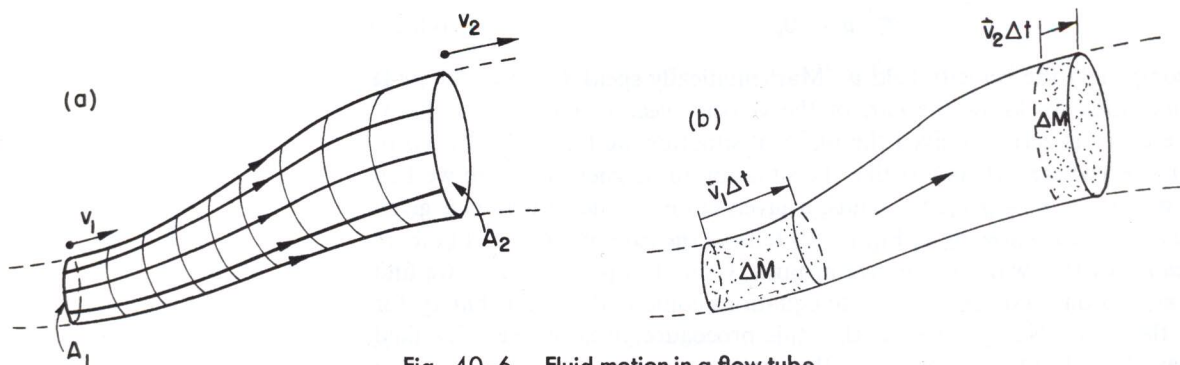

Fig. 40-6. Fluid motion in a flow tube.

The theorem of Bernoulli is in fact nothing more than a statement of the conservation of energy. A conservation theorem such as this gives us a lot of information about a flow without our actually having to solve the detailed equations. Bernoulli's theorem is so important and so simple that we would like to show you how it can be derived in a way that is different from the formal calculations we have just used. Imagine a bundle of adjacent streamlines which form a stream tube as sketched in Fig. 40-6. Since the walls of the tube consist of streamlines, no fluid flows out through the wall. Let's call the area at one end of the stream

tube A_1 , the fluid velocity there v_1 , the density of the fluid ρ_1 , and the potential energy ϕ_1 . At the other end of the tube, we have the corresponding quantities A_2 , v_2 , ρ_2 , and ϕ_2 . Now after a short interval of time Δt , the fluid at A_1 has moved a distance $v_1 \Delta t$, and the fluid at A_2 has moved a distance $v_2 \Delta t$ [Fig. 40-6(b)]. The conservation of mass requires that the mass which enters through A_1 must be equal to the mass which leaves through A_2 . These masses at these two ends must be the same:

$$\Delta M = \rho_1 A_1 v_1 \Delta t = \rho_2 A_2 v_2 \Delta t.$$

So we have the equality

$$\rho_1 A_1 v_1 = \rho_2 A_2 v_2. \quad (40.15)$$

This equation tells us that the velocity varies inversely with the area of the stream tube if ρ is constant.

Now we calculate the work done by the fluid pressure. The work done on the fluid entering at A_1 is $p_1 A_1 v_1 \Delta t$, and the work given up at A_2 is $p_2 A_2 v_2 \Delta t$. The net work on the fluid between A_1 and A_2 is, therefore,

$$p_1 A_1 v_1 \Delta t - p_2 A_2 v_2 \Delta t,$$

which must equal the increase in the energy of a mass ΔM of fluid in going from A_1 to A_2 . In other words,

$$p_1 A_1 v_1 \Delta t - p_2 A_2 v_2 \Delta t = \Delta M (E_2 - E_1), \quad (40.16)$$

where E_1 is the energy per unit mass of fluid at A_1 , and E_2 is the energy per unit mass at A_2 . The energy per unit mass of the fluid can be written as

$$E = \frac{1}{2}v^2 + \phi + U,$$

where $\frac{1}{2}v^2$ is the kinetic energy per unit mass, ϕ is the potential energy per unit mass, and U is an additional term which represents the internal energy per unit mass of fluid. The internal energy might correspond, for example, to the thermal energy in a compressible fluid, or to chemical energy. All these quantities can vary from point to point. Using this form for the energies in (40.16), we have

$$\frac{p_1 A_1 v_1 \Delta t}{\Delta M} - \frac{p_2 A_2 v_2 \Delta t}{\Delta M} = \frac{1}{2}v_2^2 + \phi_2 + U_2 - \frac{1}{2}v_1^2 - \phi_1 - U_1.$$

But we have seen that $\Delta M = \rho A v \Delta t$, so we get

$$\frac{p_1}{\rho_1} + \frac{1}{2}v_1^2 + \phi_1 + U_1 = \frac{p_2}{\rho_2} + \frac{1}{2}v_2^2 + \phi_2 + U_2, \quad (40.17)$$

which is the Bernoulli result with an additional term for the internal energy. If the fluid is incompressible, the internal energy term is the same on both sides, and we get again that Eq. (40.14) holds along any streamline.

We consider now some simple examples in which the Bernoulli integral gives us a description of the flow. Suppose we have water flowing out of a hole near the bottom of a tank, as drawn in Fig. 40-7. We take a situation in which the flow speed v_{out} at the hole is much larger than the flow speed near the top of the tank; in other words, we imagine that the diameter of the tank is so large that we can neglect the drop in the liquid level. (We could make a more accurate calculation if we wished.) At the top of the tank the pressure is p_0 , the atmospheric pressure, and the pressure at the sides of the jet is also p_0 . Now we write our Bernoulli equation for a streamline, such as the one shown in the figure. At the top of the tank, we take v equal to zero and we also take the gravity potential ϕ to be zero. At the speed v_{out} , and $\phi = -gh$, so that

$$p_0 = p_0 + \frac{1}{2}\rho v_{\text{out}}^2 - \rho gh,$$

or

$$v_{\text{out}} = \sqrt{2gh}. \quad (40.18)$$

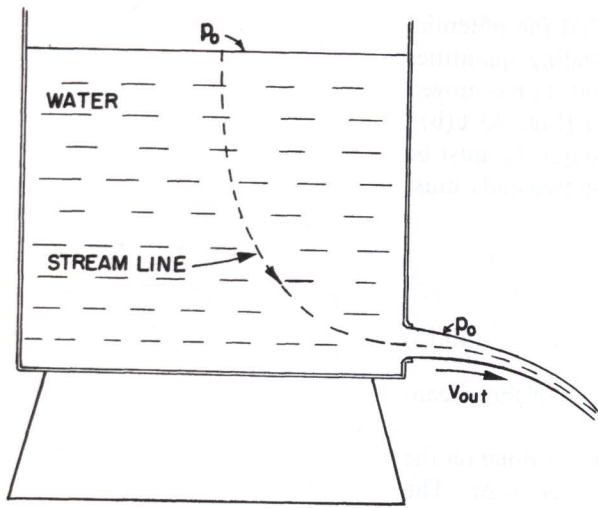

Fig. 40-7. Flow from a tank.

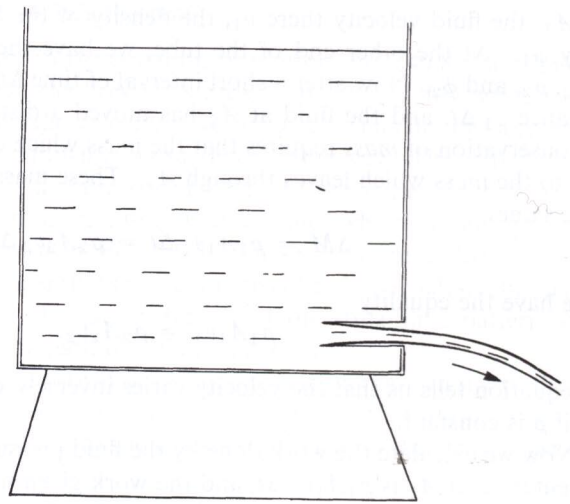

Fig. 40-8. With a re-entrant discharge tube, the stream contracts to one-half the area of the opening.

This velocity is just what we would get for something which falls the distance h . It is not too surprising, since the water at the exit gains kinetic energy at the expense of the potential energy of the water at the top. Do not get the idea, however, that you can figure out the rate that the fluid flows out of the tank by multiplying this velocity by the area of the hole. The fluid velocities as the jet leaves the hole are not all parallel to each other but have components inward toward the center of the stream—the jet is converging. After the jet has gone a little way, the contraction stops and the velocities do become parallel. So the total flow is the velocity times the area *at that point*. In fact, if we have a discharge opening which is just a round hole with a sharp edge, the jet contracts to 62 percent of the area of the hole. The reduced effective area of the discharge varies for different shapes of discharge tubes, and experimental contractions are available as tables of *efflux coefficients*.

If the discharge tube is re-entrant, as shown in Fig. 40-8, it is possible to prove in a most beautiful way that the efflux coefficient is exactly 50 percent. We will give just a hint of how the proof goes. We have used the conservation of energy to get the velocity, Eq. (40.18), but there is also momentum conservation to consider. Since there is an outflow of momentum in the discharge jet, there must be a force applied over the cross section of the discharge tube. Where does the force come from? The force must come from the pressure on the walls. As long as the efflux hole is small and away from the walls, the fluid velocity near the walls of the tank will be very small. Therefore, the pressure on every face is almost exactly the same as the static pressure in a fluid at rest—from Eq. (40.14). Then the static pressure at any point on the side of the tank must be matched by an equal pressure at the point on the opposite wall, *except* at the points on the wall opposite the discharge tube. If we calculate the momentum poured out through the jet by this pressure, we can show that the efflux coefficient is $1/2$. We cannot use this method for a discharge hole like that shown in Fig. 40-7, however, because the velocity increase along the wall right near the discharge area gives a pressure fall which we are not able to calculate.

Let's look at another example—a horizontal pipe with changing cross section, as shown in Fig. 40-9, with water flowing in one end and out the other. The conservation of energy, namely Bernoulli's formula, says that the pressure is lower in the constricted area where the velocity is higher. We can easily demonstrate this effect by measuring the pressure at different cross sections with small vertical columns of water attached to the flow tube through holes small enough so that they do not disturb the flow. The pressure is then measured by the height of water in these vertical columns. The pressure is found to be less at the constriction than it is on either side. If the area beyond the constriction comes back to the same value it had before the constriction, the pressure rises again.

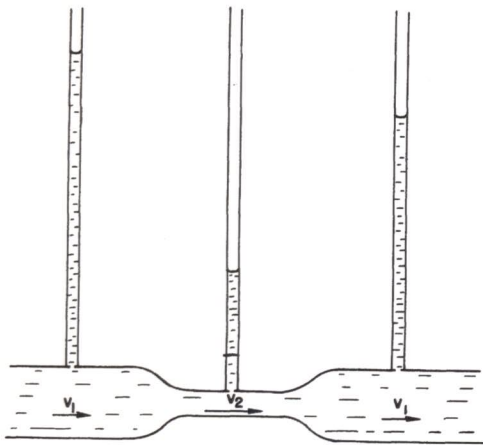

Fig. 40-9. The pressure is lowest where the velocity is highest.

Bernoulli's formula would predict that the pressure downstream of the constriction should be the same as it was upstream, but actually it is noticeably less. The reason that our prediction is wrong is that we have neglected the frictional, viscous forces which cause a pressure drop along the tube. Despite this pressure drop the pressure is definitely lower at the constriction (because of the increased speed) than it is on either side of it—as predicted by Bernoulli. The speed v_2 must certainly exceed v_1 to get the same amount of water through the narrower tube. So the water accelerates in going from the wide to the narrow part. The force that gives this acceleration comes from the drop in pressure.

We can check our results with another simple demonstration. Suppose we have on a tank a discharge tube which throws a jet of water upward as shown in Fig. 40-10. If the efflux velocity were exactly $\sqrt{2gh}$, the discharge water should rise to a level even with the surface of the water in the tank. Experimentally, it falls somewhat short. Our prediction is roughly right, but again viscous friction which has not been included in our energy conservation formula has resulted in a loss of energy.

Have you ever held two pieces of paper close together and tried to blow them apart? Try it! They come *together*. The reason, of course, is that the air has a higher speed going through the constricted space between the sheets than it does when it gets outside. The pressure between the sheets is *lower* than atmospheric pressure, so they come together rather than separating.

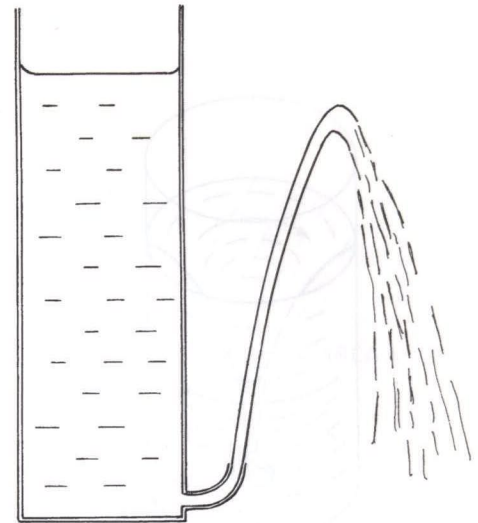

Fig. 40-10. Proof that v is not equal to $\sqrt{2gh}$.

40-4 Circulation

We saw at the beginning of the last section that if we have an incompressible fluid with no circulation, the flow satisfies the following two equations:

$$\nabla \cdot v = 0, \quad \nabla \times v = 0. \quad (40.19)$$

They are the same as the equations of electrostatics or magnetostatics in empty space. The divergence of the electric field is zero when there are no charges, and the curl of the electrostatic field is always zero. The curl of the magnetostatic field is zero if there are no currents, and the divergence of the magnetic field is always zero. Therefore, Eqs. (40.19) have the same solutions as the equations for E in electrostatics or for B in magnetostatics. As a matter of fact, we have already solved the problem of the flow of a fluid past a sphere, as an electrostatic analogy, in Section 12-5. The electrostatic analog is a uniform electric field plus a dipole field. The dipole field is so adjusted that the flow velocity normal to the surface of the sphere is zero. The same problem for the flow past a cylinder can be worked out in a similar way by using a suitable line dipole with a uniform flow field. This solution holds for a situation in which the fluid velocity at large distances is constant—both in magnitude and direction. The solution is sketched in Fig. 40-11(a).

There is another solution for the flow around a cylinder when the conditions are such that the fluid at large distances moves in circles around the cylinder. The flow is, then, circular everywhere, as in Fig. 40-11(b). Such a flow has a circulation around the cylinder, although $\nabla \times v$ is still zero *in the fluid*. How can there be circulation without a curl? We have a circulation around the cylinder because the line integral of v around any loop *enclosing* the cylinder is not zero. At the same time, the line integral of v around any closed path which does *not* include the cylinder is zero. We saw the same thing when we found the magnetic field around a wire. The curl of B was zero outside of the wire, although a line integral of B around a path which encloses the wire did not vanish. The velocity field in an irrotational circulation around a cylinder is precisely the same as the magnetic field around a wire. For a circular path with its center at the center of the cylinder, the line integral of the velocity is

$$\oint v \cdot ds = 2\pi rv.$$

For irrotational flow the integral must be independent of r . Let's call the constant

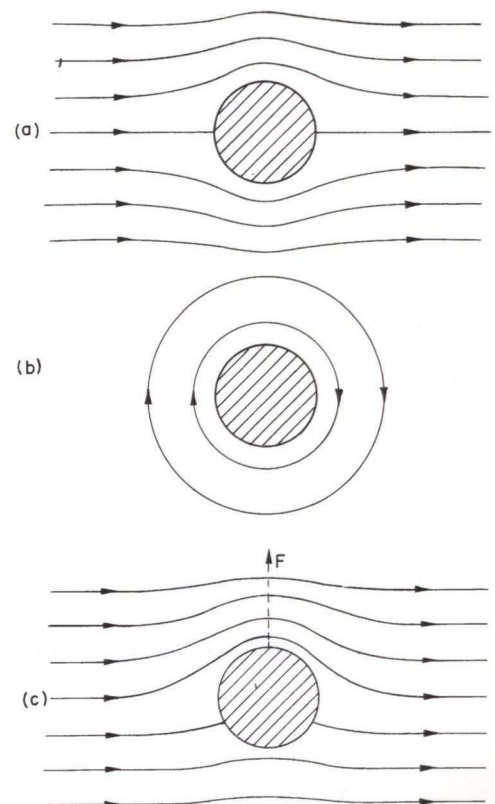

Fig. 40-11. (a) Ideal fluid flow past a cylinder. (b) Circulation around a cylinder. (c) The superposition of (a) and (b).

value C , then we have that

$$v = \frac{C}{2\pi r}, \quad (40.20)$$

where v is the tangential velocity, and r is the distance from the axis.

There is a nice demonstration of a fluid circulating around a hole. You take a transparent cylindrical tank with a drain hole in the center of the bottom. You fill it with water, stir up some circulation with a stick, and pull the drain plug. You get the pretty effect shown in Fig. 40-12. (You've seen a similar thing many times in the bathtub!) Although you put in some ω at beginning, it soon dies down because of viscosity and the flow becomes irrotational—although still with some circulation around the hole.

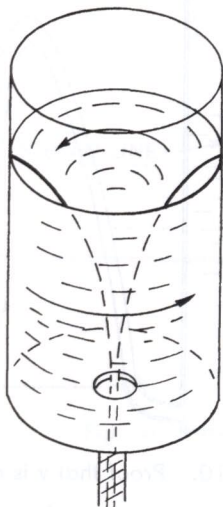

Fig. 40-12. Water with circulation draining from a tank.

From the theory, we can calculate the shape of the inner surface of the water. As a particle of the water moves inward it picks up speed. From Eq. (40.20) the tangential velocity goes as $1/r$ —it's just from the conservation of angular momentum, like the skater pulling in her arms. Also the radial velocity goes as $1/r$. Ignoring the tangential motion, we have water going radially inward toward a hole; from $\nabla \cdot v = 0$, it follows that the radial velocity is proportional to $1/r$. So the total velocity also increases as $1/r$, and the water goes in along Archimedean spirals. The air-water surface is all at atmospheric pressure, so it must have—from Eq. (40.14)—the property that

$$gz + \frac{1}{2}mv^2 = \text{const.}$$

But v is proportional to $1/r$, so the shape of the surface is

$$(z - z_0) = \frac{k}{r^2}.$$

An interesting point—which is *not true in general* but is true for incompressible, irrotational flow—is that if we have one solution and a second solution, then the sum is also a solution. This is true because the equations in (40.19) are linear. The complete equations of hydrodynamics, Eqs. (40.9), (40.10), and (40.11), are not linear, which makes a vast difference. For the irrotational flow about the cylinder, however, we can superpose the flow of Fig. 40-11(a) on the flow of Fig. 40-11(b) and get the new flow pattern shown in Fig. 40-11(c). This flow is of special interest. The flow velocity is higher on the upper side of the cylinder than on the lower side. The pressures are therefore *lower* on the *upper* side than on the lower side. So when we have a combination of a circulation around a cylinder *and* a net horizontal flow, there is a net *vertical force* on the cylinder—it is called a *lift force*. Of course, if there is no circulation, there is no net force on any body according to our theory of “dry” water.

40-5 Vortex lines

We have already written down the general equations for the flow of an incompressible fluid when there may be vorticity. They are

- I. $\nabla \cdot v = 0,$
- II. $\Omega = \nabla \times v,$
- III. $\frac{\partial \Omega}{\partial t} + \nabla \times (\Omega \times v) = 0.$

The physical content of these equations has been described in words by Helmholtz in terms of three theorems. First, imagine that in the fluid we were to draw *vortex lines* rather than streamlines. By vortex lines we mean field lines that have the direction of Ω and have a density in any region proportional to the magnitude of Ω . From II the divergence of Ω is *always* zero (remember—Section 3-7—that the divergence of a curl is always zero). So vortex lines are like lines of B —they never start or stop, and will tend to go in closed loops. Now Helmholtz described III

in words by the following statement: the vortex lines *move with the fluid*. This means that if you were to mark the fluid particles along some vortex lines—by coloring them with ink, for example—then as the fluid moves and carries those particles along, they will always mark the new positions of the vortex lines. In whatever way the atoms of the liquid move, the vortex lines move with them. That is one way to describe the laws.

It also suggests a method for solving any problems. Given the initial flow pattern—say v everywhere—then you can calculate Ω . From the v you can also tell where the vortex lines are going to be a little later—they move with the speed v . With the new Ω you can use I and II to find the new v . (That's just like the problem of finding B , given the currents.) If we are given the flow pattern at one instant we can in principle calculate it for all subsequent times. We have the general solution for nonviscous flow.

We would like to show how Helmholtz's statement—and, therefore, III—can be at least partly understood. It is really just the law of conservation of angular momentum applied to the fluid. Suppose we imagine a small cylinder of the liquid whose axis is parallel to the vortex lines, as in Fig. 40-13(a). At some time later, this *same* piece of fluid will be somewhere else. Generally it will occupy a cylinder with a different diameter and be in a different place. It may also have a different orientation, say as in Fig. 40-13(b). If the diameter has changed, however, the length will have increased to keep the volume constant (since we are assuming an incompressible fluid). Also, since the vortex lines are stuck with the material, their density will go up as the cross-sectional area goes down. The product of the vorticity Ω and area A of the cylinder will remain constant, so according to Helmholtz, we should have

$$\Omega_2 A_2 = \Omega_1 A_1. \quad (40.21)$$

Now notice that with zero viscosity all the forces on the surface of the cylindrical volume (or *any* volume, for that matter) are perpendicular to the surface. The pressure forces can cause the volume to be moved from place to place, or can cause it to change shape; but with no *tangential* forces the magnitude of the *angular momentum of the material inside* cannot change. The angular momentum of the liquid in the little cylinder is its moment of inertia I times the angular velocity of the liquid, which is proportional to the vorticity Ω . For a cylinder, the moment of inertia is proportional to mr^2 . So from the conservation of angular momentum, we would conclude that

$$(M_1 R_1^2) \Omega_1 = (M_2 R_2^2) \Omega_2.$$

But the mass is the same, $M_1 = M_2$, and the areas are proportional to R^2 , so we get again just Eq. (40.21). Helmholtz's statement—which is equivalent to III—is just a consequence of the fact that in the absence of viscosity the angular momentum of an element of the fluid cannot change.

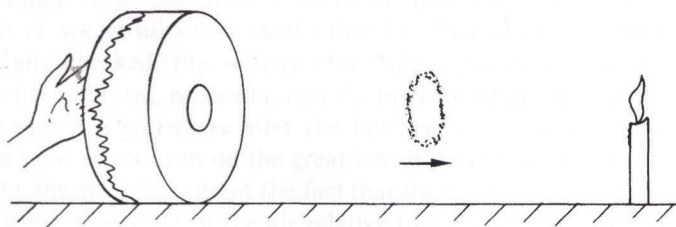

Fig. 40-14. Making a travelling vortex ring.

There is a nice demonstration of a moving vortex which is made with the simple apparatus of Fig. 40-14. It is a "drum" two feet in diameter and two feet long made by stretching a thick rubber sheet over the open end of a cylindrical "box." The "bottom"—the drum is tipped on its side—is solid except for a 3-inch diameter hole. If you give a sharp blow on the rubber diaphragm with your hand, a vortex ring is projected out of the hole. Although the vortex is invisible, you can tell it's there because it will blow out a candle 10 to 20 feet away. By the delay in

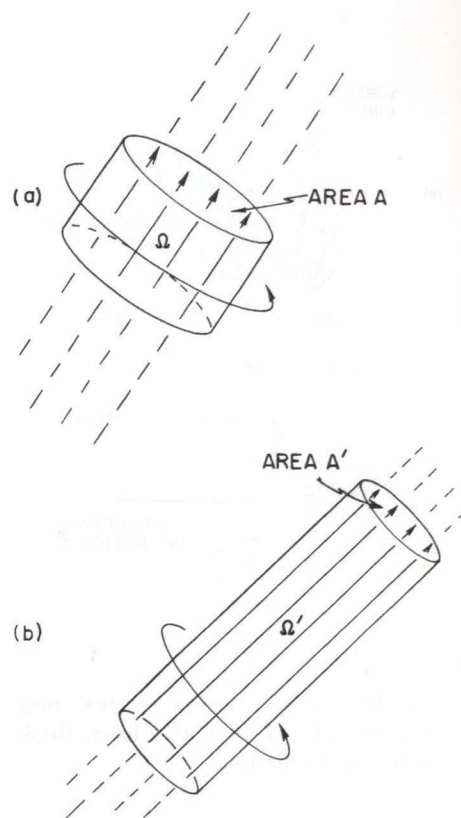

Fig. 40-13. (a) A group of vortex lines at t ; (b) the same lines at a later time t' .

the effect, you can tell that “something” is travelling at a finite speed. You can see better what is going on if you first blow some smoke into the box. Then you see the vortex as a beautiful round “smoke ring.”

The smoke ring is a torus-shaped bundle of vortex lines, as shown in Fig. 40-15(a). Since $\Omega = \nabla \times v$, these vortex lines represent also a circulation of v as shown in part (b) of the figure. We can understand the forward motion of the ring in the following way: The circulating velocity around the *bottom* of the ring extends up to the top of the ring, having there a forward motion. Since the lines of Ω move with the fluid, they also move ahead with the velocity v . (Of course, the circulation of v around the top part of the ring is responsible for the forward motion of the vortex lines at the bottom.)

We must now mention a serious difficulty. We have already noted that Eq. (40.9) says that, if Ω is initially zero, it will always be zero. This result is a great failure of the theory of “dry” water, because it means that once Ω is zero it is *always* zero—it is impossible to *produce* any vorticity under *any* circumstance. Yet, in our simple demonstration with the drum, we can generate a vortex ring starting with air which was initially at rest. (Certainly, $v = 0, \Omega = 0$ everywhere in the box before we hit it.) Also, we all know that we can start some vorticity in a lake with a paddle. Clearly, we must go to a theory of “wet” water to get a complete understanding of the behavior of a fluid.

Another feature of the dry water theory which is incorrect is the supposition we make regarding the flow at the boundary between it and the surface of a solid. When we discussed the flow past a cylinder—as in Fig. 40-11, for example—we permitted the fluid to slide along the surface of the solid. In our theory, the velocity at a solid surface could have any value depending on how it got started, and we did not consider any “friction” between the fluid and the solid. It is an experimental fact, however, that the velocity of a real fluid always goes to zero at the surface of a solid object. Therefore, our solution for the cylinder, with or without circulation, is wrong—as is our result regarding the generation of vorticity. We will tell you about the more correct theories in the next chapter.

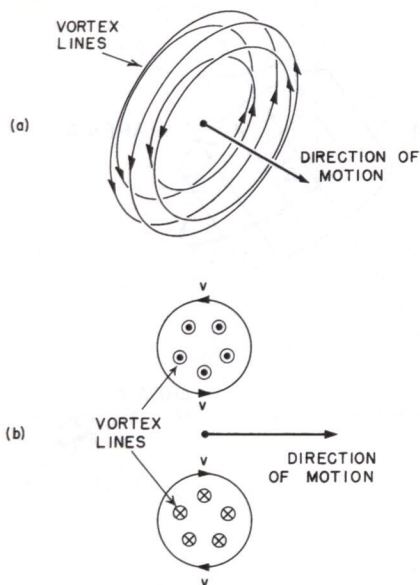

Fig. 40-15. A moving vortex ring (a smoke ring). (a) The vortex lines. (b) A cross section of the ring.

The Flow of Wet Water

41-1 Viscosity

In the last chapter we discussed the behavior of water, disregarding the phenomenon of viscosity. Now we would like to discuss the phenomena of the flow of fluids, *including* the effects of viscosity. We want to look at the *real behavior* of fluids. We will describe qualitatively the actual behavior of the fluids under various different circumstances so that you will get some feel for the subject. Although you will see some complicated equations and hear about some complicated things, it is not our purpose that you should learn all these things. This is, in a sense, a “cultural” chapter which will give you some idea of the way the world is. There is only one item which is worth learning, and that is the simple definition of viscosity which we will come to in a moment. The rest is only for your entertainment.

In the last chapter we found that the laws of motion of a fluid are contained in the equation

$$\frac{\partial \mathbf{v}}{\partial t} + (\mathbf{v} \cdot \nabla) \mathbf{v} = -\frac{\nabla p}{\rho} - \nabla \phi + \frac{\mathbf{f}_{\text{visc}}}{\rho}. \quad (41.1)$$

In our “dry” water approximation we left out the last term, so we were neglecting all viscous effects. Also, we sometimes made an additional approximation by considering the fluid as incompressible; then we had the additional equation

$$\nabla \cdot \mathbf{v} = 0.$$

This last approximation is often quite good—particularly when flow speeds are much slower than the speed of sound. But in real fluids it is almost never true that we can neglect the internal friction that we call viscosity; most of the interesting things that happen come from it in one way or another. For example, we saw that in “dry” water the circulation never changes—if there is none to start out with, there will never be any. Yet, circulation in fluids is an everyday occurrence. We must fix up our theory.

We begin with an important experimental fact. When we worked out the flow of “dry” water around or past a cylinder—the so-called “potential flow”—we had no reason not to permit the water to have a velocity tangent to the surface; only the normal component had to be zero. We took no account of the possibility that there might be a shear force between the liquid and the solid. It turns out—although it is not at all self-evident—that in all circumstances where it has been experimentally checked, the *velocity of a fluid is exactly zero at the surface of a solid*. You have noticed, no doubt, that the blade of a fan will collect a thin layer of dust—and that it is still there after the fan has been churning up the air. You can see the same effect even on the great fan of a wind tunnel. Why isn’t the dust blown off by the air? In spite of the fact that the fan blade is moving at high speed through the air, the speed of the air relative to the fan blade goes to zero right at the surface. So the very smallest dust particles are not disturbed.* We must modify the theory to agree with the experimental fact that in all ordinary fluids, the molecules next to a solid surface have zero velocity (relative to the surface).†

* You can blow large dust particles from a table top, but *not* the very finest ones. The large ones stick up into the breeze.

† You can imagine circumstances when it is not true: glass is theoretically a “liquid,” but it can certainly be made to slide along a steel surface. So our assertion must break down somewhere.

41-1 Viscosity

41-2 Viscous flow

41-3 The Reynolds number

41-4 Flow past a circular cylinder

41-5 The limit of zero viscosity

41-6 Couette flow

Fig. 41-1. Viscous drag between two parallel plates.

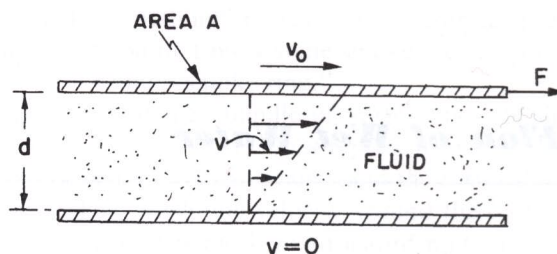

We originally characterized a liquid by the fact that if you put a shearing stress on it—no matter how small—it would give way. It flows. In static situations, there are no shear stresses. But before equilibrium is reached—as long as you still push on it—there can be shear forces. *Viscosity* describes these shear forces which exist in a moving fluid. To get a measure of the shear forces during the motion of a fluid, we consider the following kind of experiment. Suppose that we have two solid plane surfaces with water between them, as in Fig. 41-1, and we keep one stationary while moving the other parallel to it at the slow speed v_0 . If you measure the force required to keep the upper plate moving, you find that it is proportional to the area of the plates and to v_0/d , where d is the distance between the plates. So the shear stress F/A is proportional to v_0/d :

$$\frac{F}{A} = \eta \frac{v_0}{d}.$$

The constant of proportionality η is called the *coefficient of viscosity*.

If we have a more complicated situation, we can always consider a little, flat, rectangular cell in the water with its faces parallel to the flow, as in Fig. 41-2. The shear force across this cell is given by

$$\frac{\Delta F}{\Delta A} = \eta \frac{\Delta v_x}{\Delta y} = \eta \frac{\partial v_x}{\partial y}. \quad (41.2)$$

Now, $\partial v_x/\partial y$ is the *rate of change* of the shear strain we defined in Chapter 39, so for a liquid, the shear stress is proportional to the *rate of change* of the shear strain.

In the general case we write

$$S_{xy} = \eta \left(\frac{\partial v_y}{\partial x} + \frac{\partial v_x}{\partial y} \right). \quad (41.3)$$

If there is a uniform rotation of the fluid, $\partial v_x/\partial y$ is the negative of $\partial v_y/\partial x$ and S_{xy} is zero—as it should be since there are no stresses in a uniformly rotating fluid. (We did a similar thing in defining e_{xy} in Chapter 39.) There are, of course, the corresponding expressions for S_{yz} and S_{zx} .

As an example of the application of these ideas, we consider the motion of a fluid between two coaxial cylinders. Let the inner one have the radius a and the peripheral velocity v_a , and let the outer one have radius b and velocity v_b . See Fig. 41-3. We might ask, what is the velocity distribution between the cylinders? To answer this question, we begin by finding a formula for the viscous shear in the fluid at a distance r from the axis. From the symmetry of the problem, we can assume that the flow is always tangential and that its magnitude depends only on r ; $v = v(r)$. If we watch a speck in the water at the radius r , its coordinates as a function of time are

$$x = r \cos \omega t, \quad y = r \sin \omega t,$$

where $\omega = v/r$. Then the x - and y -components of velocity are

$$v_x = -r\omega \sin \omega t = -\omega y \quad \text{and} \quad v_y = r\omega \cos \omega t = \omega x. \quad (41.4)$$

From Eq. (41.3), we have

$$S_{xy} = \eta \left[\frac{\partial}{\partial x} (\omega x) - \frac{\partial}{\partial y} (\omega y) \right] = \eta \left[x \frac{\partial \omega}{\partial x} - y \frac{\partial \omega}{\partial y} \right]. \quad (41.5)$$

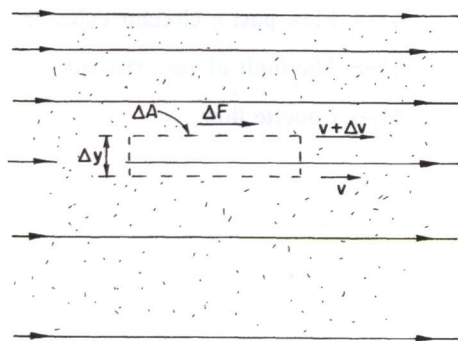

Fig. 41-2. The shear stress in a viscous fluid.

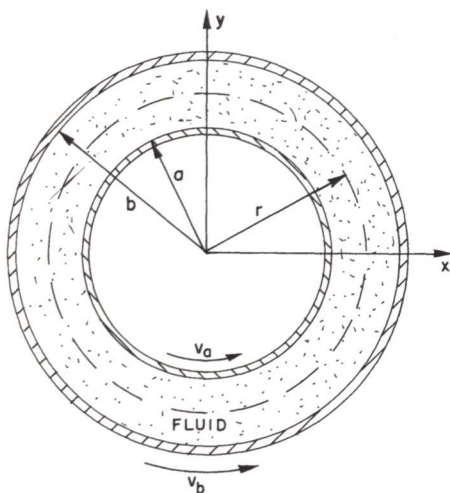

Fig. 41-3. The flow in a fluid between two concentric cylinders rotating at different angular velocities.

For a point at $y = 0$, $\partial\omega/\partial y = 0$, and $x \partial\omega/\partial x$ is the same as $r d\omega/dr$. So at that point

$$(S_{xy})_{y=0} = \eta r \frac{d\omega}{dr}. \quad (41.6)$$

(It is reasonable that S should depend on $\partial\omega/\partial r$; when there is no change in ω with r , the liquid is in uniform rotation and there are no stresses.)

The stress we have calculated is the tangential shear which is the same all around the cylinder. We can get the *torque* acting *across a cylindrical surface* at the radius r by multiplying the shear stress by the moment arm r and the area $2\pi r l$ (where l is the length of the cylinder). We get

$$\tau = 2\pi r^2 l (S_{xy})_{y=0} = 2\pi \eta l r^3 \frac{d\omega}{dr}. \quad (41.7)$$

Since the motion of the water is steady—there is no angular acceleration—the net torque on the cylindrical shell of water between r and $r + dr$ must be zero; that is, the torque at r must be balanced by an equal and opposite torque at $r + dr$, so that τ must be independent of r . In other words, $r^3 d\omega/dr$ is equal to some constant, say A , and

$$\frac{d\omega}{dr} = \frac{A}{r^3}. \quad (41.8)$$

Integrating, we find that ω varies with r as

$$\omega = -\frac{A}{2r^2} + B. \quad (41.9)$$

The constants A and B are to be determined to fit the conditions that $\omega = \omega_a$ at $r = a$, and $\omega = \omega_b$ at $r = b$. We get that

$$\begin{aligned} A &= \frac{2a^2 b^2}{b^2 - a^2} (\omega_b - \omega_a), \\ B &= \frac{b^2 \omega_b - a^2 \omega_a}{b^2 - a^2}. \end{aligned} \quad (41.10)$$

So we know ω as a function of r , and from it $v = \omega r$.

If we want the torque, we can get it from Eqs. (41.7) and (41.8):

$$\tau = 2\pi \eta l A$$

or

$$\tau = \frac{4\pi \eta l a^2 b^2}{b^2 - a^2} (\omega_b - \omega_a). \quad (41.11)$$

It is proportional to the relative angular velocities of the two cylinders. One standard apparatus for measuring the coefficients of viscosity is built this way. One cylinder—say the outer one—is on pivots but is held stationary by a spring balance which measures the torque on it, while the inner one is rotated at a constant angular velocity. The coefficient of viscosity is then determined from Eq. (41.11).

From its definition, you see that the units of η are newton-sec/m². For water at 20°C,

$$\eta = 10^3 \text{ newton-sec/m}^2.$$

It is usually more convenient to use the *specific viscosity*, which is η divided by the density ρ . The values for water and air are then comparable:

$$\begin{aligned} \text{water at } 20^\circ\text{C}, \quad \eta/\rho &= 10^{-6} \text{ m}^2/\text{sec}, \\ \text{air at } 20^\circ\text{C}, \quad \eta/\rho &= 15 \times 10^{-6} \text{ m}^2/\text{sec}. \end{aligned} \quad (41.12)$$

Viscosities usually depend strongly on temperature. For instance, for water just above the freezing point, η/ρ is 1.8 times larger than it is at 20°C.

41-2 Viscous flow

We now go to a general theory of viscous flow—at least in the most general form known to man. We already understand that the shear stress components are proportional to the spatial derivatives of the various velocity components such as $\partial v_x/\partial y$ or $\partial v_y/\partial x$. However, in the general case of a *compressible* fluid there is another term in the stress which depends on other derivatives of the velocity. The general expression is

$$S_{ij} = \eta \left(\frac{\partial v_i}{\partial x_j} + \frac{\partial v_j}{\partial x_i} \right) + \eta' \delta_{ij} (\nabla \cdot \mathbf{v}), \quad (41.13)$$

where x_i is any one of the rectangular coordinates x , y , or z , and v_i is any one of the rectangular coordinates of the velocity. (The symbol δ_{ij} is the Kronecker delta which is 1 when $i = j$ and 0 for $i \neq j$.) The additional term adds $\eta' \nabla \cdot \mathbf{v}$ to all the diagonal elements S_{ii} of the stress tensor. If the liquid is incompressible $\nabla \cdot \mathbf{v} = 0$, and this extra term doesn't appear. So it has to do with internal forces during compression. So two constants are required to describe the liquid, just as we had two constants to describe a homogeneous elastic solid. The coefficient η is the "ordinary" coefficient of viscosity which we have already encountered. It is also called the *first coefficient of viscosity* or the "shear viscosity coefficient," and the new coefficient η' is called the *second coefficient of viscosity*.

Now we want to determine the viscous force per unit volume, f_{visc} , so we can put it into Eq. (41.1) to get the equation of motion for a real fluid. The force on a small cubical volume element of a fluid is the resultant of the forces on all the six faces. Taking them two at a time, we will get differences that depend on the derivatives of the stresses, and, therefore, on the second derivatives of the velocity. This is nice because it will get us back to a vector equation. The component of the viscous force per unit volume in the direction of the rectangular coordinate x_i is

$$\begin{aligned} (f_{\text{visc}})_i &= \sum_{j=1}^3 \frac{\partial S_{ij}}{\partial x_j} \\ &= \eta \sum_{j=1}^3 \frac{\partial}{\partial x_j} \left\{ \eta \left(\frac{\partial v_i}{\partial x_j} + \frac{\partial v_j}{\partial x_i} \right) \right\} + \frac{\partial}{\partial x_i} (\eta' \nabla \cdot \mathbf{v}). \end{aligned} \quad (41.14)$$

Usually, the variation of the viscosity coefficients with position is not significant and can be neglected. Then, the viscous force per unit volume contains only second derivatives of the velocity. We saw in Chapter 39 that the most general form of second derivatives that can occur in a vector equation is the sum of a term in the Laplacian ($\nabla \cdot \nabla \mathbf{v} = \nabla^2 \mathbf{v}$), and a term in the gradient of the divergence ($\nabla(\nabla \cdot \mathbf{v})$). Equation (41.14) is just such a sum with the coefficients η and $(\eta + \eta')$. We get

$$f_{\text{visc}} = \eta \nabla^2 \mathbf{v} + (\eta + \eta') \nabla(\nabla \cdot \mathbf{v}). \quad (41.15)$$

In the incompressible case, $\nabla \cdot \mathbf{v} = 0$, and the viscous force per unit volume is just $\eta \nabla^2 \mathbf{v}$. That is all that many people use; however, if you should want to calculate the absorption of sound in a fluid, you would need the second term.

We can now complete our general equation of motion for a real fluid. Substituting Eq. (41.15) into Eq. (41.1), we get

$$\rho \left\{ \frac{\partial \mathbf{v}}{\partial t} + (\mathbf{v} \cdot \nabla) \mathbf{v} \right\} = -\nabla p - \rho \nabla \phi + \eta \nabla^2 \mathbf{v} + (\eta + \eta') \nabla(\nabla \cdot \mathbf{v}).$$

It's complicated. But that's the way nature is.

If we introduce the vorticity $\boldsymbol{\Omega} = \nabla \times \mathbf{v}$, as we did before, we can write our equation as

$$\begin{aligned} \rho \left\{ \frac{\partial \mathbf{v}}{\partial t} + \boldsymbol{\Omega} \times \mathbf{v} + \frac{1}{2} \nabla v^2 \right\} &= -\nabla p - \rho \nabla \phi + \eta \nabla^2 \mathbf{v} \\ &+ (\eta + \eta') \nabla(\nabla \cdot \mathbf{v}). \end{aligned} \quad (41.16)$$

We are supposing again that the only body forces acting are conservative forces like gravity. To see what the new term means, let's look at the incompressible fluid case. Then, if we take the curl of Eq. (41.16), we get

$$\frac{\partial \Omega}{\partial t} + \nabla \times (\Omega \times v) = \frac{\eta}{\rho} \nabla^2 \Omega. \quad (41.17)$$

This is like Eq. (40.9) except for the new term on the right-hand side. When the right-hand side was zero, we had the Helmholtz theorem that the vorticity stays with the fluid. Now, we have the rather complicated nonzero term on the right-hand side which, however, has straightforward physical consequences. If we disregard for the moment the term $\nabla \times (\Omega \times v)$, we have a *diffusion equation*. The new term means that the vorticity Ω *diffuses* through the fluid. If there is a large gradient in the vorticity, it will spread out into the neighboring fluid.

This is the term that causes the smoke ring to get thicker as it goes along. Also, it shows up nicely if you send a "clean" vortex (a "smokeless" ring made by the apparatus described in the last chapter) through a cloud of smoke. When it comes out of the cloud, it will have picked up some smoke, and you will see a hollow shell of a smoke ring. Some of the Ω diffuses outward into the smoke, while still maintaining its forward motion with the vortex.

41-3 The Reynolds number

We will now describe the changes which are made in the character of fluid flow as a consequence of the new viscosity term. We will look at two problems in some detail. The first of these is the flow of a fluid past a cylinder—a flow which we tried to calculate in the previous chapter using the theory for nonviscous flow. It turns out that the viscous equations can be solved by man today only for a few special cases. So some of what we will tell you is based on experimental measurements—assuming that the experimental model satisfies Eq. (41.17).

The mathematical problem is this: We would like the solution for the flow of an incompressible, viscous fluid past a long cylinder of diameter D . The flow should be given by Eq. (41.17) and by

$$\Omega = \nabla \times v \quad (41.18)$$

with the conditions that the velocity at large distances is some constant velocity, say V (parallel to the x -axis), and at the surface of the cylinder is zero. That is,

$$v_x = v_y = v_z = 0 \quad (41.19)$$

for

$$x^2 + y^2 = \frac{D^2}{4}.$$

That specifies completely the mathematical problem.

If you look at the equations, you see that there are four different parameters to the problem: η , ρ , D , and V . You might think that we would have to give a whole series of cases for different V 's, different D 's, and so on. However, that is not the case. All the different possible solutions correspond to different values of *one parameter*. This is the most important general thing we can say about viscous flow. To see why this is so, notice first that the viscosity and density appear only in the ratio η/ρ —the *specific viscosity*. That reduces the number of independent parameters to three. Now suppose we measure all distances in the only length that appears in the problem, the diameter D of the cylinder; that is, we substitute for x , y , z , the new variables x' , y' , z' with

$$x = x'D, \quad y = y'D, \quad z = z'D.$$

Then D disappears from (41.19). In the same way, if we measure all velocities in terms of V —that is, we set $v = v'V$ —we get rid of the V , and v' is just equal to 1 at large distances. Since we have fixed our units of length and velocity, our unit

of time is now D/V ; so we should set

$$t = t' \frac{D}{V}. \quad (41.20)$$

With our new variables, the derivatives in Eq. (41.18) get changed from $\partial/\partial x$ to $(1/D) \partial/\partial x'$, and so on; so Eq. (41.18) becomes

$$\Omega = \nabla \times v = \frac{V}{D} \nabla' \times v' = \frac{V}{D} \Omega'. \quad (41.21)$$

Our main equation (41.17) then reads

$$\frac{\partial \Omega'}{\partial t'} + \nabla' \times (\Omega' \times v') = \frac{\eta}{\rho V D} \nabla'^2 \Omega'.$$

All the constants condense into one factor which we write, following tradition, as $1/\mathcal{R}$:

$$\mathcal{R} = \frac{\rho}{\eta} V D. \quad (41.22)$$

If we just remember that all of our equations are to be written with all quantities in the new units, we can omit all the primes. Our equations for the flow are then

$$\frac{\partial \Omega}{\partial t} + \nabla \times (\Omega \times v) = \frac{1}{\mathcal{R}} \nabla^2 \Omega \quad (41.23)$$

and

$$\Omega = \nabla \times v$$

with the conditions

$$v = 0$$

for

$$x^2 + y^2 = 1/4 \quad (41.24)$$

and

$$v_x = 1, \quad v_y = v_z = 0$$

for

$$x^2 + y^2 + z^2 \gg 1.$$

What this all means physically is very interesting. It means, for example, that if we solve the problem of the flow for one velocity V_1 and a certain cylinder diameter D_1 , and then ask about the flow for a different diameter D_2 and a different fluid, the flow will be the same for the velocity V_2 which gives the same Reynolds number—that is, when

$$\mathcal{R}_1 = \frac{\rho_1}{\eta_1} V_1 D_1 = \mathcal{R}_2 = \frac{\rho_2}{\eta_2} V_2 D_2. \quad (41.25)$$

For any two situations which have the same Reynolds number, the flows will “look” the same—in terms of the appropriate scaled x' , y' , z' , and t' . This is an important proposition because it means that we can determine what the behavior of the flow of air past an airplane wing will be without having to build an airplane and try it. We can, instead, make a model and make measurements using a velocity that gives the same Reynolds number. This is the principle which allows us to apply the results of “wind-tunnel” measurements on small-scale airplanes, or “model-basin” results on scale model boats, to the full-scale objects. Remember, however, that we can only do this provided the compressibility of the fluid can be neglected. Otherwise, a new quantity enters—the speed of sound. And different situations will really correspond to each other only if the ratio of V to the sound speed is also the same. This latter ratio is called the *Mach number*. So, for velocities near the speed of sound or above, the flows are the same in two situations if *both* the *Mach number* and the *Reynolds number* are the same for both situations.

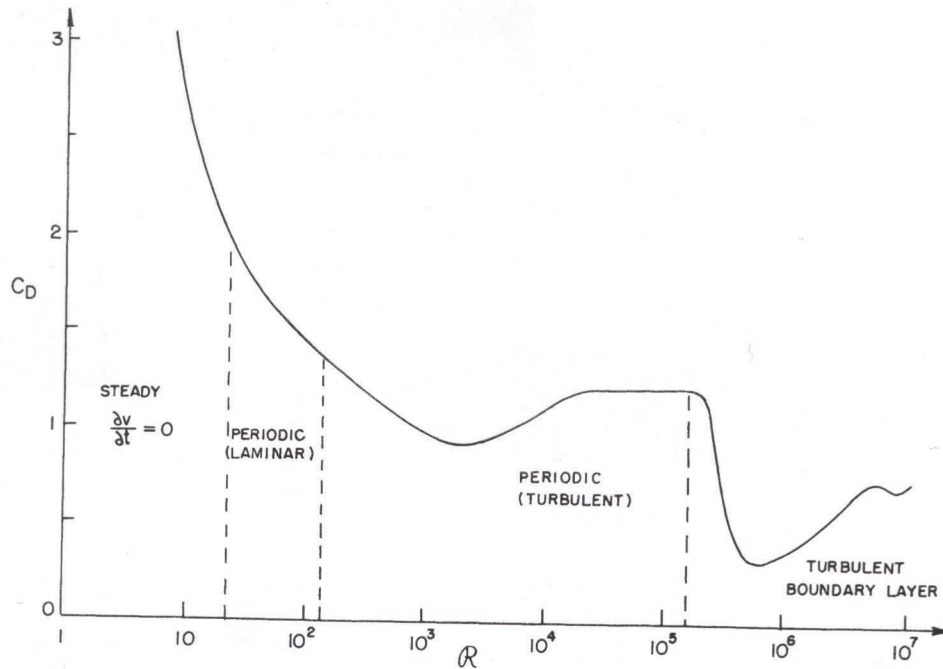

Fig. 41-4. The drag coefficient C_D of a circular cylinder as a function of the Reynolds number.

41-4 Flow past a circular cylinder

Let's go back to the problem of low-speed (nearly incompressible) flow over the cylinder. We will give a qualitative description of the flow of a real fluid. There are many things we might want to know about such a flow—for instance, what is the drag force on the cylinder? The drag force on a cylinder is plotted in Fig. 41-4 as a function of R —which is proportional to the air speed V if everything else is held fixed. What is actually plotted is the so-called *drag coefficient* C_D , which is a dimensionless number equal to the force divided by $\frac{1}{2}\rho V^2 D l$, where D is the diameter, l is the length of the cylinder, and ρ is the density of the liquid:

$$C_D = \frac{F}{\frac{1}{2}\rho V^2 D l}$$

The coefficient of drag varies in a rather complicated way, giving us a pre-hint that something rather interesting and complicated is happening in the flow. We will now describe the nature of flow for the different ranges of the Reynolds number. First, when the Reynolds number is very small, the flow is quite steady; that is, the velocity is constant at any place, and the flow goes around the cylinder. The actual distribution of the flow lines is, however, not like it is in potential flow. They are solutions of a somewhat different equation. When the velocity is very low or, what is equivalent, when the viscosity is very high so the stuff is like honey, then the inertial terms are negligible and the flow is described by the equation

$$\nabla^2 \Omega = 0.$$

This equation was first solved by Stokes. He also solved the same problem for a sphere. If you have a small sphere moving under such conditions of low Reynolds number, the force needed to drag it is equal to $6\pi\eta aV$, where a is the radius of the sphere and V is its velocity. This is a very useful formula because it tells the speed at which tiny grains of dirt (or other particles which can be approximated as spheres) move through a fluid under a given force—as, for instance, in a centrifuge, or in sedimentation, or diffusion. In the low Reynolds number region—for R less than 1—the lines of v around a *cylinder* are as drawn in Fig. 41-5.

If we now increase the fluid speed to get a Reynolds number somewhat greater than 1, we find that the flow is different. There is a circulation behind the sphere, as shown in Fig. 41-6(b). It is still an open question as to whether there is always

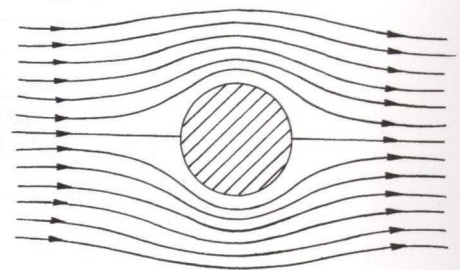

Fig. 41-5. Viscous flow (low velocities) around a circular cylinder.

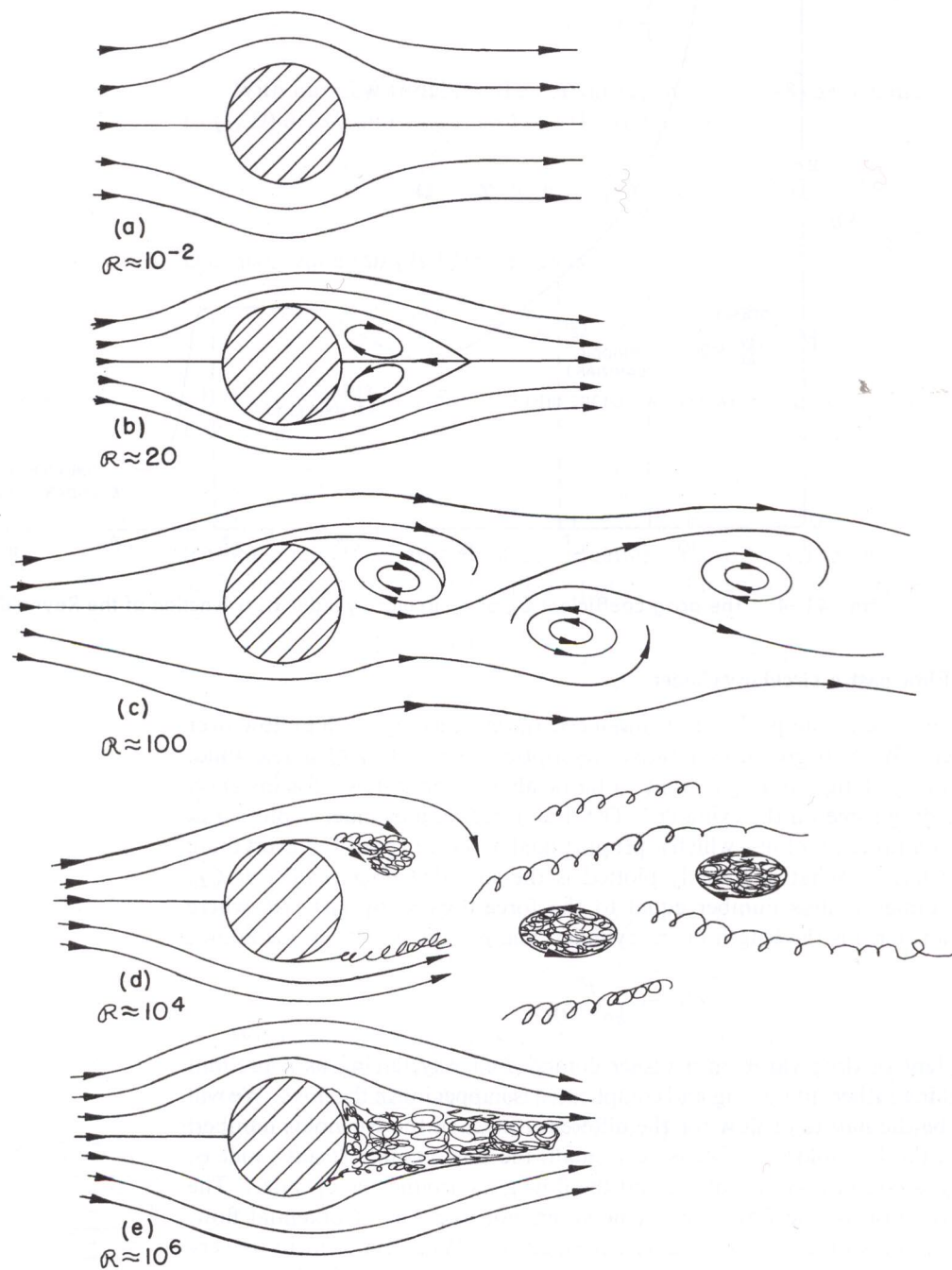

Fig. 41-6. Flow past a cylinder for various Reynolds numbers.

a circulation there even at the smallest Reynolds number or whether things suddenly change at a certain Reynolds number. It used to be thought that the circulation grew continuously. But it is now thought that it appears suddenly, and it is certain that the circulation increases with R . In any case, there is a different character to the flow for R in the region from about 10 to 30. There is a pair of vortices behind the cylinder.

The flow changes again by the time we get to a number of 40 or so. There is suddenly a complete change in the character of the motion. What happens is that one of the vortices behind the cylinder gets so long that it breaks off and travels downstream with the fluid. Then the fluid curls around behind the cylinder and makes a new vortex. The vortices peel off alternately on each side, so an instantaneous view of the flow looks roughly as sketched in Fig. 41-6(c). The stream of

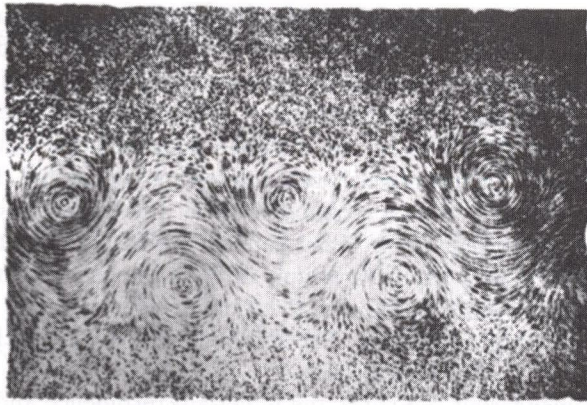

Fig. 41-7. Photograph by Ludwig Prandtl of the "vortex street" in the flow behind a cylinder.

vortices is called a "Kármán vortex street." They always appear for $\mathcal{R} > 40$. We show a photograph of such a flow in Fig. 41-7.

The difference between the two flows in Fig. 41-6(c) and 41-6(b) or 41-6(a) is almost a complete difference in regime. In Fig. 41-6(a) or (b), the velocity is constant, whereas in Fig. 41-6(c), the velocity at any point varies with time. There is no steady solution above $\mathcal{R} = 40$ —which we have marked on Fig. 41-4 by a dashed line. For these higher Reynolds numbers, the flow varies with time but in a regular, cyclic fashion.

We can get a physical idea of how these vortices are produced. We know that the fluid velocity must be zero at the surface of the cylinder and that it also increases rapidly away from that surface. Vorticity is created by this large local variation in fluid velocity. Now when the main stream velocity is low enough, there is sufficient time for this vorticity to diffuse out of the thin region near the solid surface where it is produced and to grow into a large region of vorticity. This physical picture should help to prepare us for the next change in the nature of the flow as the main stream velocity, or \mathcal{R} , is increased still more.

As the velocity gets higher and higher, there is less and less time for the vorticity to diffuse into a larger region of fluid. By the time we reach a Reynolds number of several hundred, the vorticity begins to fill in a thin band, as shown in Fig. 41-6(d). In this layer the flow is chaotic and irregular. The region is called the *boundary layer* and this irregular flow region works its way farther and farther upstream as \mathcal{R} is increased. In the turbulent region, the velocities are very irregular and "noisy"; also the flow is no longer two-dimensional but twists and turns in all three dimensions. There is still a regular alternating motion superimposed on the turbulent one.

As the Reynolds number is increased further, the turbulent region works its way forward until it reaches the point where the flow lines leave the cylinder—for flows somewhat above $\mathcal{R} = 10^5$. The flow is as shown in Fig. 41-6(e), and we have what is called a "turbulent boundary layer." Also, there is a drastic change in the drag force; it drops by a large factor, as shown in Fig. 41-4. In this speed region, the drag force actually *decreases* with increasing speed. There seems to be little evidence of periodicity.

What happens for still larger Reynolds numbers? As we increase the speed further, the wake increases in size again and the drag increases. The latest experiments—which go up to $\mathcal{R} = 10^7$ or so—indicate that a new periodicity appears in the wake, either because the whole wake is oscillating back and forth in a gross motion or because some new kind of vortex is occurring together with an irregular noisy motion. The details are as yet not entirely clear, and are still being studied experimentally.

41-5 The limit of zero viscosity

We would like to point out that none of the flows we have described are anything like the potential flow solution we found in the preceding chapter. This is, at first sight, quite surprising. After all, \mathcal{R} is proportional to $1/\eta$. So η going to zero is equivalent to \mathcal{R} going to infinity. And if we take the limit of large \mathcal{R} in

Eq. (41.23), we get rid of the right-hand side and get just the equations of the last chapter. Yet, you would find it hard to believe that the highly turbulent flow at $\mathcal{R} = 10^7$ was approaching the smooth flow computed from the equations of “dry” water. How can it be that as we approach $\mathcal{R} = \infty$, the flow described by Eq. (41.23) gives a completely different solution from the one we obtained taking $\eta = 0$ to start out with? The answer is very interesting. Note that the right-hand term of Eq. (41.23) has $1/\mathcal{R}$ times a *second derivative*. It is a higher derivative than any other derivative in the equation. What happens is that although the coefficient $1/\mathcal{R}$ is small, there are very rapid variations of Ω in the space near the surface. These rapid variations compensate for the small coefficient, and the product *does not go to zero* with increasing \mathcal{R} . The solutions do not approach the limiting case as the coefficient of $\nabla^2\Omega$ goes to zero.

You may be wondering, “What is the fine-grain turbulence and how does it maintain itself? How can the vorticity which is made somewhere at the edge of the cylinder generate so much noise in the background?” The answer is again interesting. Vorticity has a tendency to amplify itself. If we forget for a moment about the diffusion of vorticity which causes a loss, the laws of flow say (as we have seen) that the vortex lines are carried along with the fluid, at the velocity v . We can imagine a certain number of lines of Ω which are being distorted and twisted by the complicated flow pattern of v . This pulls the lines closer together and mixes them all up. Lines that were simple before will get knotted and pulled close together. They will be longer and tighter together. The strength of the vorticity will increase and its irregularities—the pluses and minuses—will, in general, increase. So the magnitude of vorticity in three dimensions increases as we twist the fluid about.

You might well ask, “When is the potential flow a satisfactory theory at all?” In the first place, it is satisfactory outside the turbulent region where the vorticity has not entered appreciably by diffusion. By making special streamlined bodies, we can keep the turbulent region as small as possible; the flow around airplane wings—which are carefully designed—is almost entirely true potential flow.

41-6 Couette flow

It is possible to demonstrate that the complex and shifting character of the flow past a cylinder is not special but that the great variety of flow possibilities occurs generally. We have worked out in Section 1 a solution for the viscous flow between two cylinders, and we can compare the results with what actually happens. If we take two concentric cylinders with an oil in the space between them and put a fine aluminum powder as a suspension in the oil, the flow is easy to see. Now if we turn the outer cylinder slowly, nothing unexpected happens; see Fig. 41-8(a). Alternatively, if we turn the inner cylinder slowly, nothing very striking occurs. However, if we turn the inner cylinder at a higher rate, we get a surprise. The fluid breaks into horizontal bands, as indicated in Fig. 41-8(b). When the outer cylinder rotates at a similar rate with the inner one at rest, no such effect occurs. How can it be that there is a difference between rotating the inner or the out cylinder? After all, the flow pattern we derived in Section 1 depended only on $\omega_b - \omega_a$. We can get the answer by looking at the cross sections shown in Fig. 41-9. When the inner layers of the fluid are moving more rapidly than the outer ones, they tend to move *outward*—the centrifugal force is larger than the pressure holding them in place. A whole layer cannot move out uniformly because the outer layers are in the way. It must break into cells and circulate, as shown in Fig. 41-9(b). It is like the convection currents in a room which has hot air at the bottom. When the inner cylinder is at rest and the outer cylinder has a high velocity, the centrifugal forces build up a pressure gradient which keeps everything in equilibrium—see Fig. 41-9(c) (as in a room with hot air at the top).

Now let's speed up the inner cylinder. At first, the number of bands increases. Then suddenly you see the bands become wavy, as in Fig. 41-8(c), and the waves travel around the cylinder. The speed of these waves is easily measured. For high rotation speeds they approach $1/3$ the speed of the inner cylinder. And no one

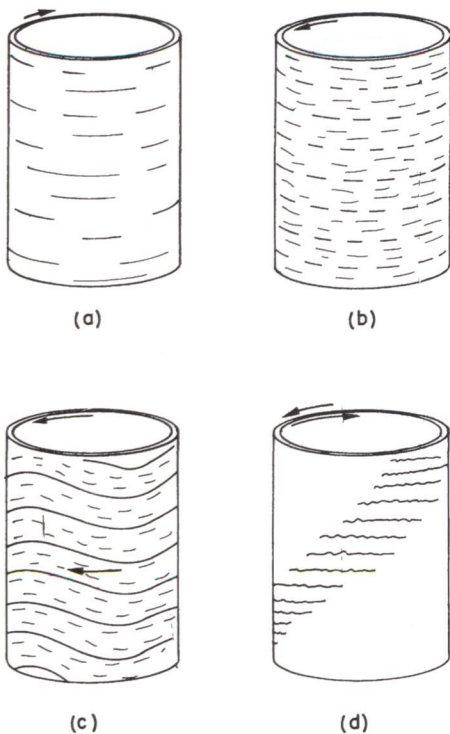

Fig. 41-8. Liquid flow patterns between two transparent rotating cylinders.

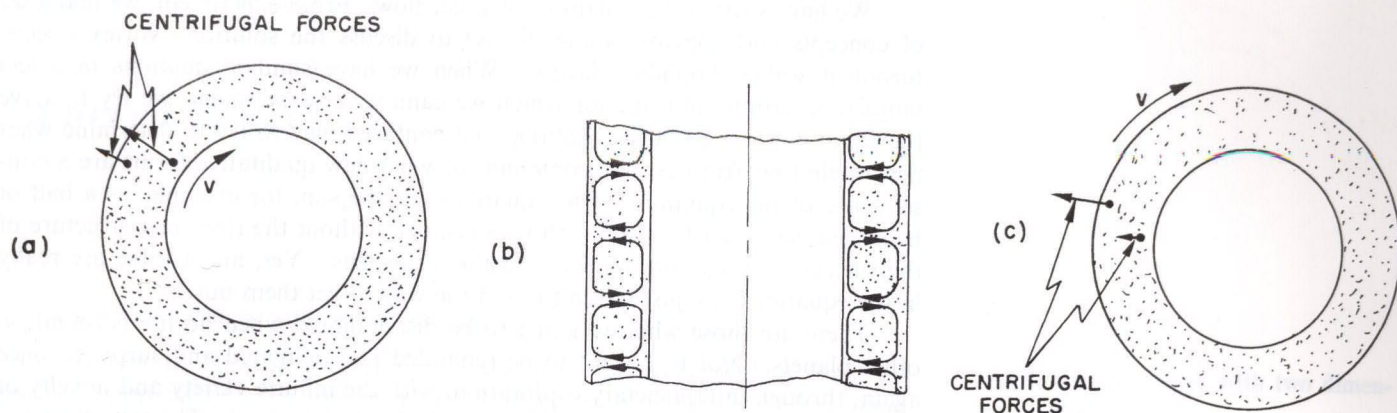

Fig. 41-9. Why the flow breaks up into bands.

knows why! There's a challenge. A simple number like $1/3$, and no explanation. In fact, the whole mechanism of the wave formation is not very well understood; yet it is steady laminar flow.

If we now start rotating the outer cylinder also—but in the opposite direction—the flow pattern starts to break up. We get wavy regions alternating with apparently quiet regions, as sketched in Fig. 41-8(d), making a spiral pattern. In these “quiet” regions, however, we can see that the flow is really quite irregular; it is, in fact completely turbulent. The wavy regions also begin to show irregular turbulent flow. If the cylinders are rotated still more rapidly, the whole flow becomes chaotically turbulent.

In this simple experiment we see many interesting regimes of flow which are quite different, and yet which are all contained in our simple equation for various values of the one parameter \mathcal{R} . With our rotating cylinders, we can see many of the effects which occur in the flow past a cylinder: first, there is a steady flow; second, a flow sets in which varies in time but in a regular, smooth way; finally, the flow becomes completely irregular. You have all seen the same effects in the column of smoke rising from a cigarette in quiet air. There is a smooth steady column followed by a series of twistings as the stream of smoke begins to break up, ending finally in an irregular churning cloud of smoke.

The main lesson to be learned from all of this is that a tremendous variety of behavior is hidden in the simple set of equations in (41.23). All the solutions are for the same equations, only with different values of \mathcal{R} . We have no reason to think that there are any terms missing from these equations. The only difficulty is that we do not have the mathematical power today to analyze them except for very small Reynolds numbers—that is, in the completely viscous case. That we have written an equation does not remove from the flow of fluids its charm or mystery or its surprise.

If such variety is possible in a simple equation with only one parameter, how much more is possible with more complex equations! Perhaps the fundamental equation that describes the swirling nebulae and the condensing, revolving, and exploding stars and galaxies is just a simple equation for the hydrodynamic behavior of nearly pure hydrogen gas. Often, people in some unjustified fear of physics say you can't write an equation for life. Well, perhaps we can. As a matter of fact, we very possibly already have the equation to a sufficient approximation when we write the equation of quantum mechanics:

$$H\psi = -\frac{\hbar}{i} \frac{\partial \psi}{\partial t}.$$

We have just seen that the complexities of things can so easily and dramatically escape the simplicity of the equations which describe them. Unaware of the scope of simple equations, man has often concluded that nothing short of God, not mere equations, is required to explain the complexities of the world.

We have written the equations of water flow. From experiment, we find a set of concepts and approximations to use to discuss the solution—vortex streets, turbulent wakes, boundary layers. When we have similar equations in a less familiar situation, and one for which we cannot yet experiment, we try to solve the equations in a primitive, halting, and confused way to try to determine what new qualitative features may come out, or what new qualitative forms are a consequence of the equations. Our equations for the sun, for example, as a ball of hydrogen gas, describe a sun without sunspots, without the rice-grain structure of the surface, without prominences, without coronas. Yet, all of these are really in the equations; we just haven't found the way to get them out.

There are those who are going to be disappointed when no life is found on other planets. Not I—I want to be reminded and delighted and surprised once again, through interplanetary exploration, with the infinite variety and novelty of phenomena that can be generated from such simple principles. The test of science is its ability to predict. Had you never visited the earth, could you predict the thunderstorms, the volcanos, the ocean waves, the auroras, and the colorful sunset? A salutary lesson it will be when we learn of all that goes on on each of those dead planets—those eight or ten balls, each agglomerated from the same dust cloud and each obeying exactly the same laws of physics.

The next great era of awakening of human intellect may well produce a method of understanding the *qualitative* content of equations. Today we cannot. Today we cannot see that the water flow equations contain such things as the barber pole structure of turbulence that one sees between rotating cylinders. Today we cannot see whether Schrödinger's equation contains frogs, musical composers, or morality—or whether it does not. We cannot say whether something beyond it like God is needed, or not. And so we can all hold strong opinions either way.